

# TECNOMEDEX - DATA SHEET

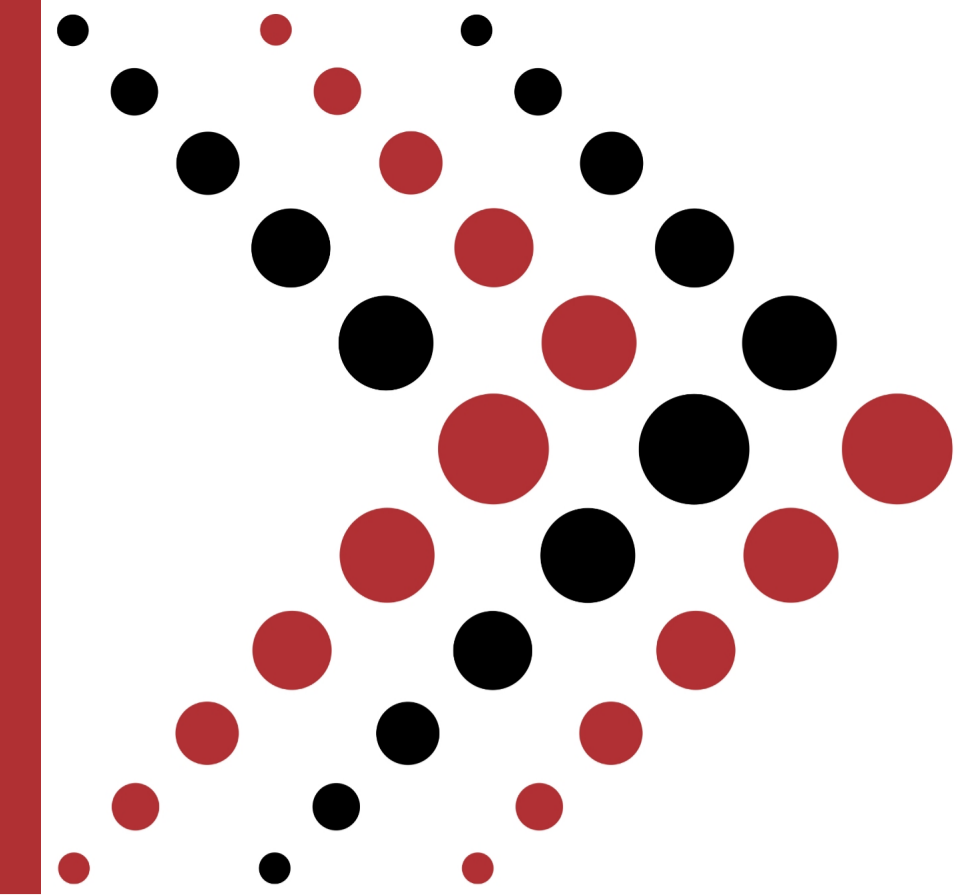

Stainless Steel Grate (Abadis - Slotted)

L 1000 \* W 100 \* H 10 mm

Code: G-0045

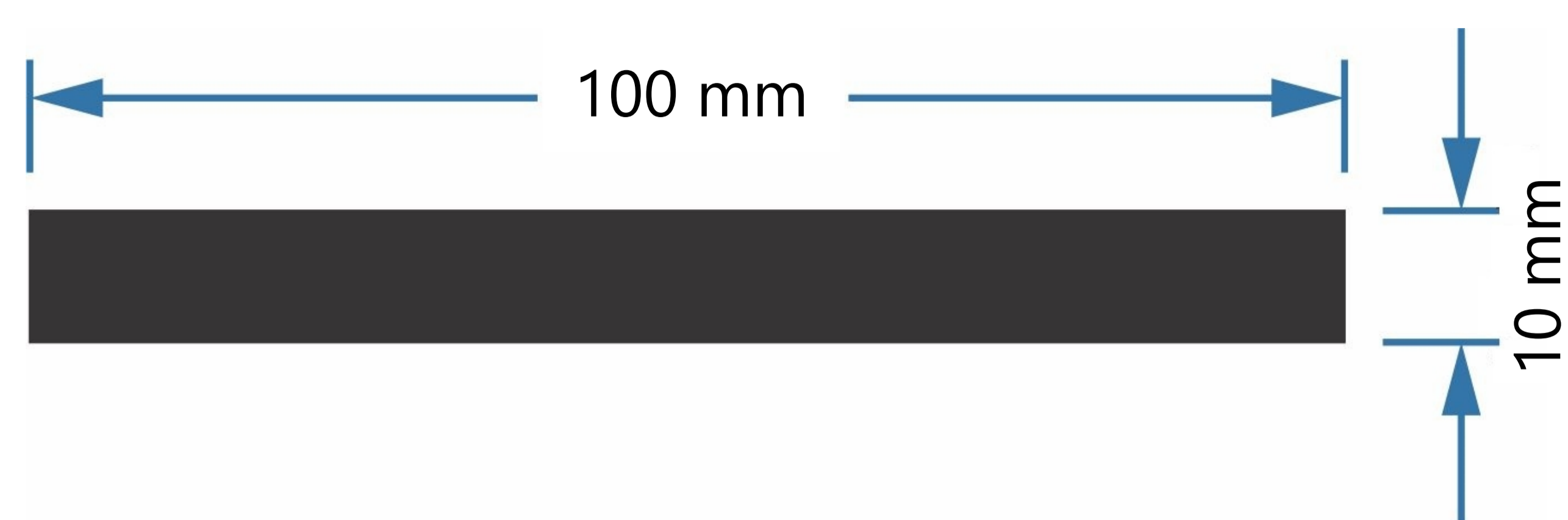

## Description

- This product is assembled on pre-fabricated channels or concrete trench platforms
- This product is certified in accordance with EN1433 standard and holds CE certification

## Application

- Pedestrian zone, bicycle, and motorcycle commute areas
- Flat roofs, terraces, and balconies
- Markets and school yards
- Industrial kitchens and storage areas
- Public showers and bathrooms



## Technical Details

- Load class: A15
- Color: gray
- Grate length is 1 m
- Grate type: stainless steel (Abadis - slotted)

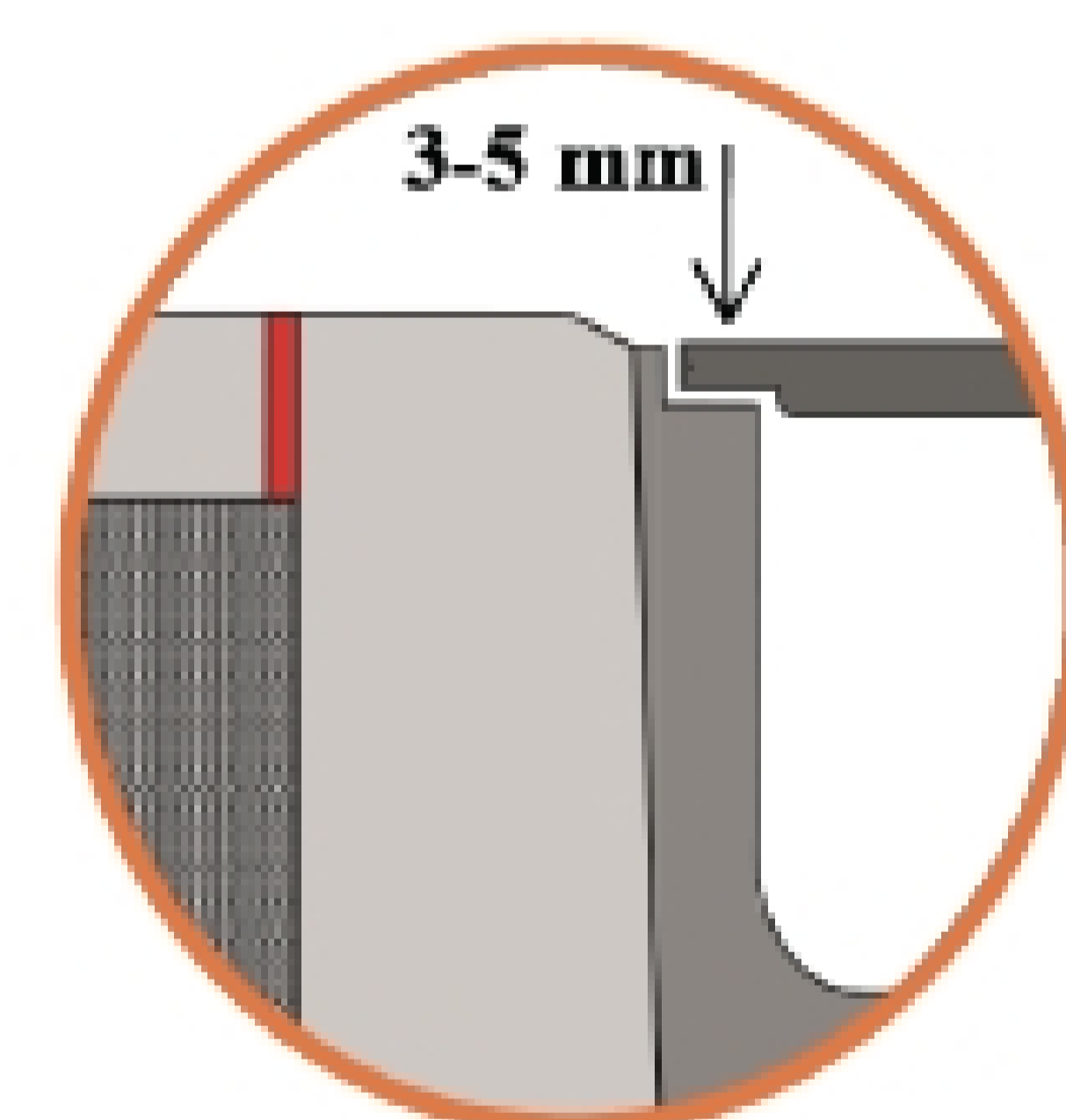
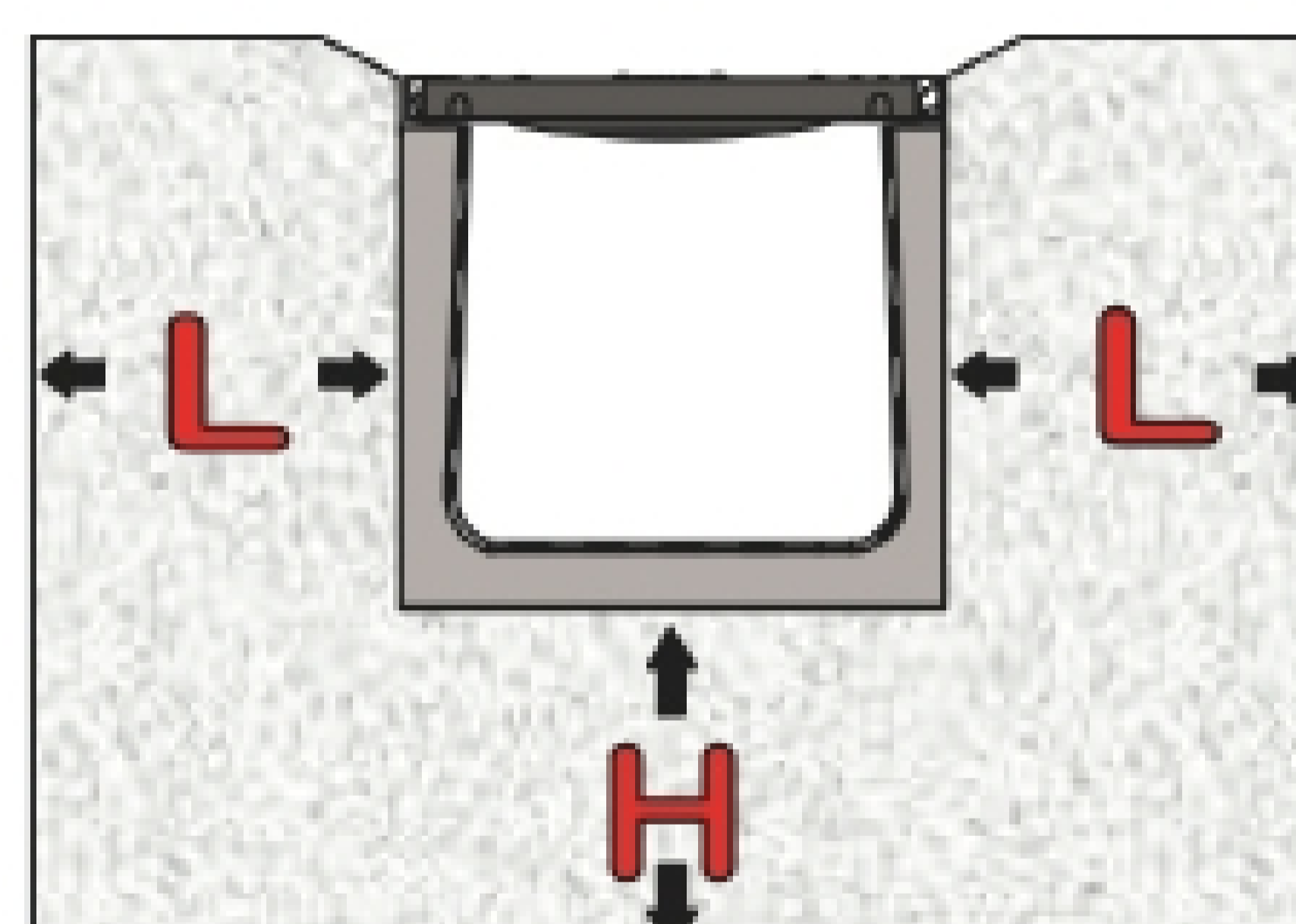

## Installation

See table below

Dimensions							
Load Class		Class A	Class B	Class C	Class D	Class E	Class F
Concrete Bed Size	H	100 mm	100 mm	150 mm	150 mm	200 mm	200 mm
Concrete Lateral Backfill Size	L	100 mm	100 mm	150 mm	150 mm	200 mm	200 mm